

## KL3H7L PHOTO TRANSISTOR

### SSOP4 晶体管光耦

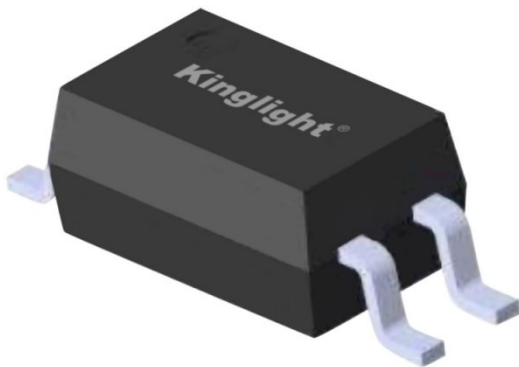

\* 本文中包含的信息反映了具有代表性的使用场景，仅供技术参考。

The information contained in this document reflects representative usage scenarios and is intended for technical reference only.

\* 本文中提到的产品型号和规格如有更改或改进，恕不另行通知。在生产使用之前，客户应参考产品规格书的最新数据表。

Product models and specifications mentioned in this document are subject to change or improvement without notice. Customers should refer to the latest data sheets in the product specifications prior to production use.

\* 在使用本文中引用的产品时，请确保产品在数据手册中规定的环境和电气限制范围内运行。如果客户使用超过指定的限制，晶台将不会对任何后续问题负责。

When using the products referenced in this document, ensure that the products are operated within the environmental and electrical limits specified in the data sheet. If the customer uses the product beyond the specified limits, Kinglight will not be responsible for any subsequent problems.

\* 本文档中的信息适用于电子元器件应用中的典型用法。如有任何特殊用途，请向晶台咨询，以获得进一步的帮助。

The information in this document applies to typical use in electronic component applications. For special applications, please contact Kinglight for further assistance.

\* 未经晶台允许，不得复制或转载本文件的内容和信息。对于最新的信息，请参考官方网站 [Http://www.kinglight-OC.com](http://www.kinglight-OC.com)。

The contents and information in this document may not be copied or reproduced without the permission of Kinglight. For the latest information, please visit the official website [Http://www.kinglight-OC.com](http://www.kinglight-OC.com).

## 1. 产品特点 Product features

- 电流转换率(Current transfer ratio)  
CTR: 50~600% at  $I_F = 0.1\text{mA}$ ,  $V_{CE} = 5\text{V}$
- 输入与输出间高隔离电压(Viso=3750 V rms)  
High isolation voltage between input and output (Viso=3750 V rms)
- 外形为2.0mm的紧凑型4pin SSOP  
Compact 4 Pin SSOP with a 2.0 mm profile
- 符合无卤素(溴<900ppm, 氯<900ppm, 溴+氯<1500ppm)  
Compliance Halogen Free (Br < 900ppm, Cl < 900ppm, Br+Cl < 1500ppm)
- 符合欧盟REACH法规 Compliance with EU REACH
- 无Pb且符合ROHS标准 Pb free and compliant with RoHS standards

## 2. 产品描述 Product Description

- KL3H7L型是由一个红外发射二极管和光电晶体管构成光电耦合器  
The KL3H7L series devices consist of an infrared emitting diode, optically coupled to a phototransistor detector encapsulated with green compound.
- 它们被封装在一个4引脚小外形SMD中。  
They are packaged in a 4-pin small outline SMD package

## 3. 产品应用 Product Applications

- DC-DC转换器 DC-DC Converters
- 可编程序控制器 Programmable controllers
- 电信设备 Telecommunication equipment
- 不同电位,不同阻抗的电路之间的信号传输  
Signal transmission between circuits of different potentials and impedances

## 4. 功能图 Functional Diagram

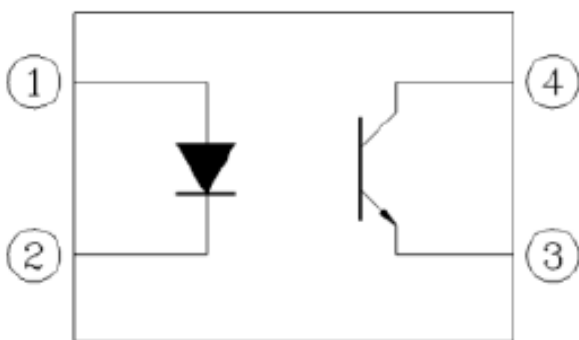

引脚配置 Pin Configuration

1. 阳极 Anode
2. 阴极 Cathode
3. 发射极 Emitter
4. 集电极 Collector

## 5. 光电特性 Electrical-Optical characteristics

• 最大限度额定值(温度=25°C) Absolute Maximum Ratings(Ta=25°C)

参数 Parameter		符号 Symbol	额定值 Rated Value	单位 Unit
输入 Input	正向电流 Forward current	$I_F$	50	mA
	峰值正向电流(1us脉冲) Peak forward current (1us, pulse)	$I_{FP}$	1	A
	反向电压 Reverse voltage	$V_R$	6	V
	功耗 Power dissipation	$P_D$	70	mW
	降额系数(高于Ta=90°C以上) Derating factor (above Ta=90°C)	$P_D$	2.0	mW/°C
输出 Output	集电极电流 Collector current	$I_C$	50	mA
	集电极-发射极电压 Collector and emitter Voltage	$V_{CEO}$	80	V
	发射极-集电极电压 Emitter and Collector Voltage	$V_{ECO}$	7	V
	功耗 Power dissipation	$P_C$	150	mW
	降额系数(高于Ta=70°C以上) Derating factor (above Ta=70°C)	$P_C$	3.1	mW/°C
总功耗 Total Consume Power		$P_{TOT}$	200	mW
隔离电压 (1*) Isolation Voltage		$V_{iso}$	3750	Vrms
工作温度 Operating temperature		$T_{OPR}$	-55 to +110	°C
储存温度 Storage temperature		$T_{STG}$	-55 to +125	°C
焊接温度(2*) Soldering temperature		$T_{SOL}$	260	°C

附注(Notes):

1\* 交流电源1分钟内, 相对湿度40~60%环境下, 隔离电压测试方法, 引脚1&2短接在一起, 引脚3&4短接在一起  
AC for 1 minute, 40~60%RH in this test, Pins 1,2 are shorted together, and 3,4 are shorted together

2\* 焊接时间为10秒 Soldering time is 10 seconds

## 6. 电气特性(Ta=25°C,除非另有规定)

## Electrical Characteristics(Ta=25°C unless specified otherwise)

参数 Parameter		符号 Symbol	最小值 Min.	规格值 Typ.	最大值 Max.	单位 Unit	条件 Condition
输入 Input	正向电压 Forward voltage	$V_F$	-	1.3	1.5	V	$I_F=20\text{mA}$
	反向电流 Reverse current	$I_R$	-	-	10	$\mu\text{A}$	$V_R=6\text{V}$
	输入电容 Input capacitance	$C_{in}$	-	30	250	pF	$V=0, f=1\text{kHz}$
输出 Output	集电极暗电流 Collector-Emitter dark current	$I_{CEO}$	-	-	100	nA	$V_{CE}=20\text{V}$ $I_F=0\text{mA}$
	集电极-发射极击穿电压 Collector-Emitter breakdown voltage	$V_{CEO}$	80	-	-	V	$I_C=0.1\text{mA}$ $I_F=0\text{mA}$
	发射极-集电极击穿电压 Emitter-Collector breakdown voltage	$V_{ECO}$	7	-	-	V	$I_E=0.1\text{mA}$ $I_F=0\text{mA}$
传输特性 Transfer Characteristics	KL3H7L 电流传输比 Current Transferratio	CTR	50	-	600	%	$I_F=0.1\text{mA}$ $V_{CE}=5\text{V}$
	集电极-发射极饱和压降 Collector-Emitter saturation voltage	$V_{CE(sat)}$	-	-	0.3	V	$I_F=10\text{mA}$ $I_C=1\text{mA}$
	隔离电阻 Isolation resistance	$R_{ISO}$	$5 \times 10^{10}$	-	-	$\Omega$	$V_{IO}=500\text{Vdc}$ 40~60% R.H.
	浮动电容 Floating capacitor	$C_f$	-	0.3	1.0	pF	$V_{IO}=0\text{V}$ $f=1\text{MHz}$
	上升时间 Response Time (Rise)	$t_r$	-	8	18	$\mu\text{s}$	$V_{CE}=2\text{V}$ $I_C=2\text{mA}$ $R_L=100\Omega$
	下降时间 Response Time (Fall)	$t_f$	-	12	18	$\mu\text{s}$	

• 温度Ta=25°C下规格值 Typical values at Ta = 25°C

## 7. 可靠性试验 Reliability Test

序号 NO.	试验项目 Test Items	参考标准 Reference	试验条件 Test conditions	试验过程 Test process	试验数 Qty.(pcs)	允收水准 LTPD
1	温度循环 TC	JESD22-A104C	H:125±5°C 15min J5min L:-55±5°C 15min	300cycle	45	0/45
2	高温操作寿命 HTOL	JESD22-A108C	HTOL@110°±5C I <sub>F</sub> =10mA I <sub>C</sub> =10mA	168、500、 1000hrs	45	0/45
3	高温反向偏压 HTRB	JESD22-A108C	HTRB@125±5°C V <sub>ce</sub> =60V	168、500、 1000hrs	45	0/45
4	温湿度反向偏 压寿命试验 H3TRB	JESD22-A101- B	H3TRB@ 85±5°C、 85±5%RH V <sub>ce</sub> =60V	168、500、 1000hrs	45	0/45
5	压力锅 Autoclave	JESD22-A102- C	T <sub>a</sub> =121±5°C, 100±5%RH, 2atm	96hrs	45	0/45
6	高温储存 HTS	JESD22-A103C	HTS@125±5°C	168、500、 1000hrs	45	0/45
7	低温储存 LTS	JESD22-A119	LTS@-55±5°C	168、500、 1000hrs	45	0/45
8	耐锡热试验 RSH	JESD22-B106C	RSH@260±5°C	10sec*3times	45	0/45
9	可焊性 SD	JESD22-B102D	Pb-free@ 245±5°C	3sec*1times	22	0/22
备注 Remarks	以上试验项目如与客户试验要求存在差异或者特殊客户特殊要求的,可根据实际情况按照客户的要求进行试 作,客户未要求依我司试验标准试作,不同产品使用不同电流进行测试 All the tests should be performed according to customers' actual requirements, while difference of test standard or special requirements exist. Otherwise, all the tests are performed according to the standard listed above. Different current is applied to the tests of different product models					

### 8. 特性曲线 Characteristic Curves

图 1.正向电流与正向电压曲线图

Figure1.Forward Current vs Forward Voltage



图 2.电流传输比与正向电流曲线图

Figure2. Normalized Current Transfer Ratio vs Forward Current

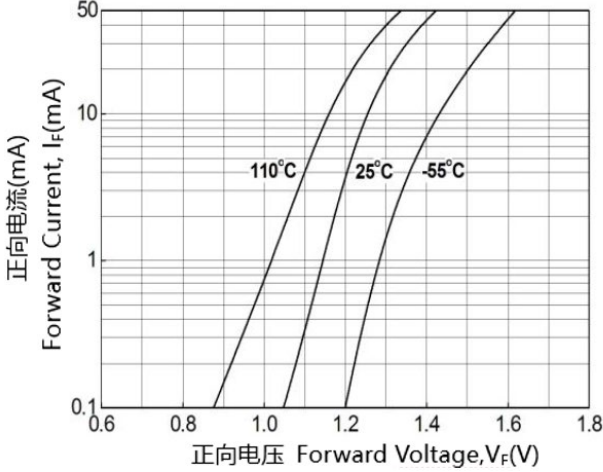

图 3.电流传输比与环境温度曲线图

Figure3. Current Transfer Ratio vs Ambient Temperature

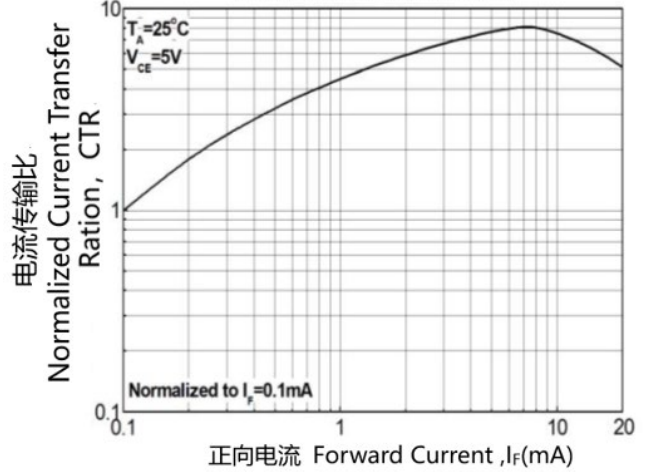

图 4. 集电极暗电流与环境温度曲线图

Figure4. Dark Current vs Ambient Temperature

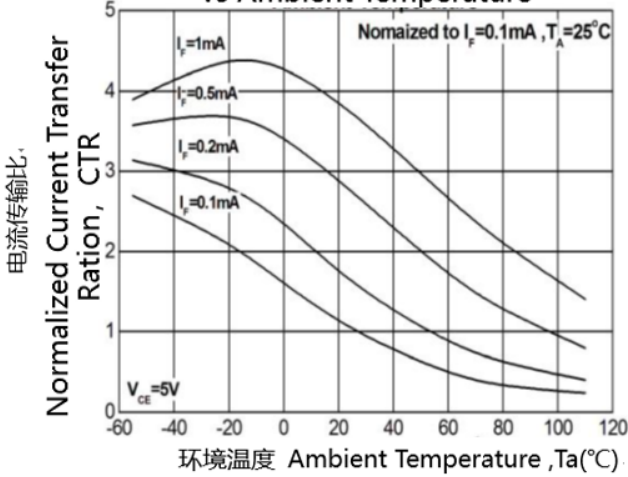

图 5. 集电极-发射极饱和电压与集电极电流曲线图

Figure5. Collector-Emitter Saturation Voltage vs Collector Current

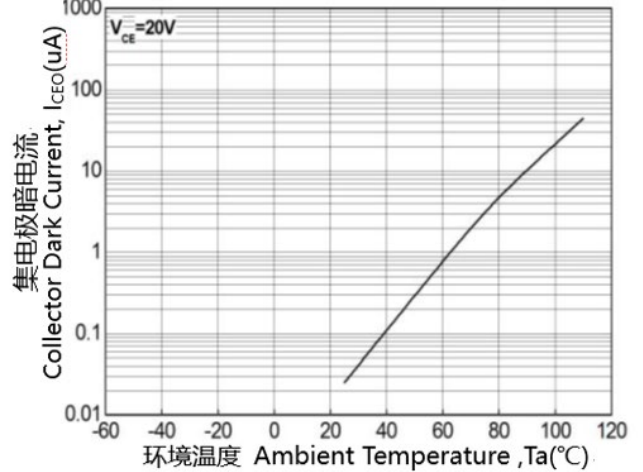

图 6. 响应时间和负载电阻曲线图

Figure6. Switching Time vs Load Resistance

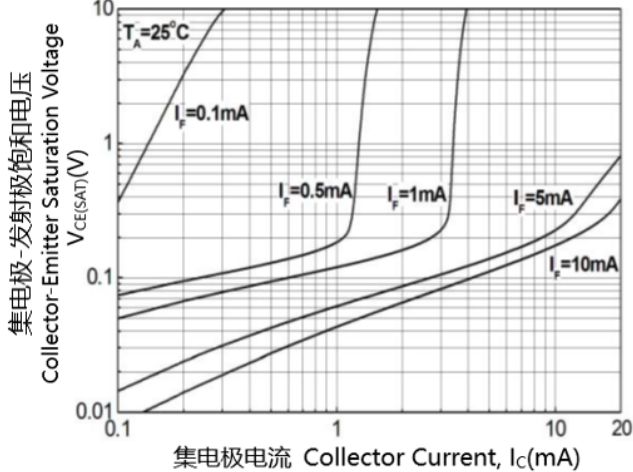

图7 开关时间测试电路及波形

Fig7. Switching Time Test Circuit & Waveforms

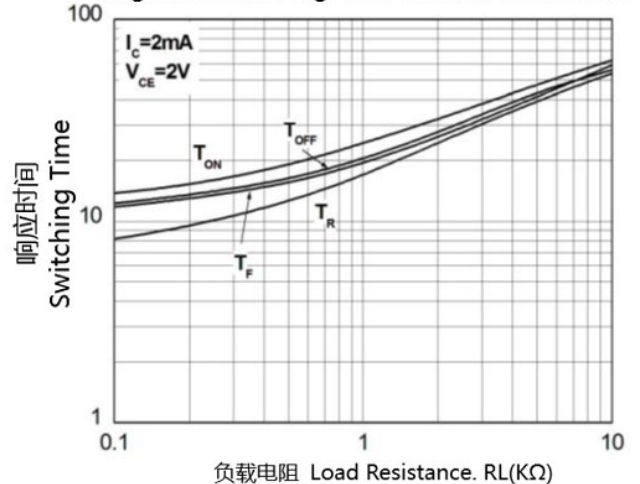
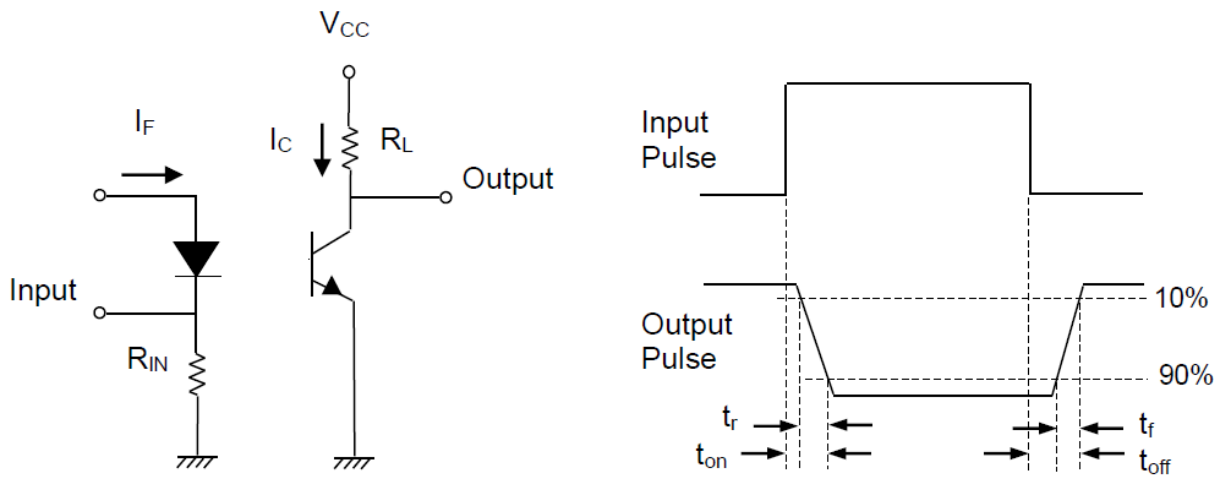

## 9. 订单信息 Order Information

- 零件编号 Part Number

### KL3H7L-X-V

#### 附注(Notes):

L = 表示小电流运行

Operating at low current

X = 载带和卷轴包装方式(TA、TB、EA、EB 或 无)

Tape and reel option (TA, TB, EA, EB or none)

V =表示VDE标识(客户指定镭射字符才加"V")

VDE (Only add "V" to laser characters specified by the customer)

选项 Option	描述 Description	包装数量 Packing quantity
None	标准SMD选项 Standard SMD option	每管150pcs 150 units per tube
-V	标准SMD选项+VDE Standard SMD option+VDE	每管150pcs 150 units per tube
(TA)	TA料带 & 卷轴选择 TA tape & reel option	每卷5000pcs 5000 units per reel
(TB)	TB料带 & 卷轴选择 TB tape & reel option	每卷5000pcs 5000 units per reel
(TA)-V	TA料带 & 卷轴选择+VDE TA tape & reel option+VDE	每卷5000pcs 5000 units per reel
(TB)-V	TB料带 & 卷轴选择+VDE TB tape & reel option+VDE	每卷5000pcs 5000 units per reel
/	内盒装:每盒3卷 Inner box packaging:3 reels/box	每盒15000pcs 15000 pcs per box
/	每箱装:10个内盒 Pack per Carton:10 inner boxes	每箱150000pcs 150000 pcs per reel Carton



10. 封装尺寸(单位:毫米) Package Drawing(Unit:mm)

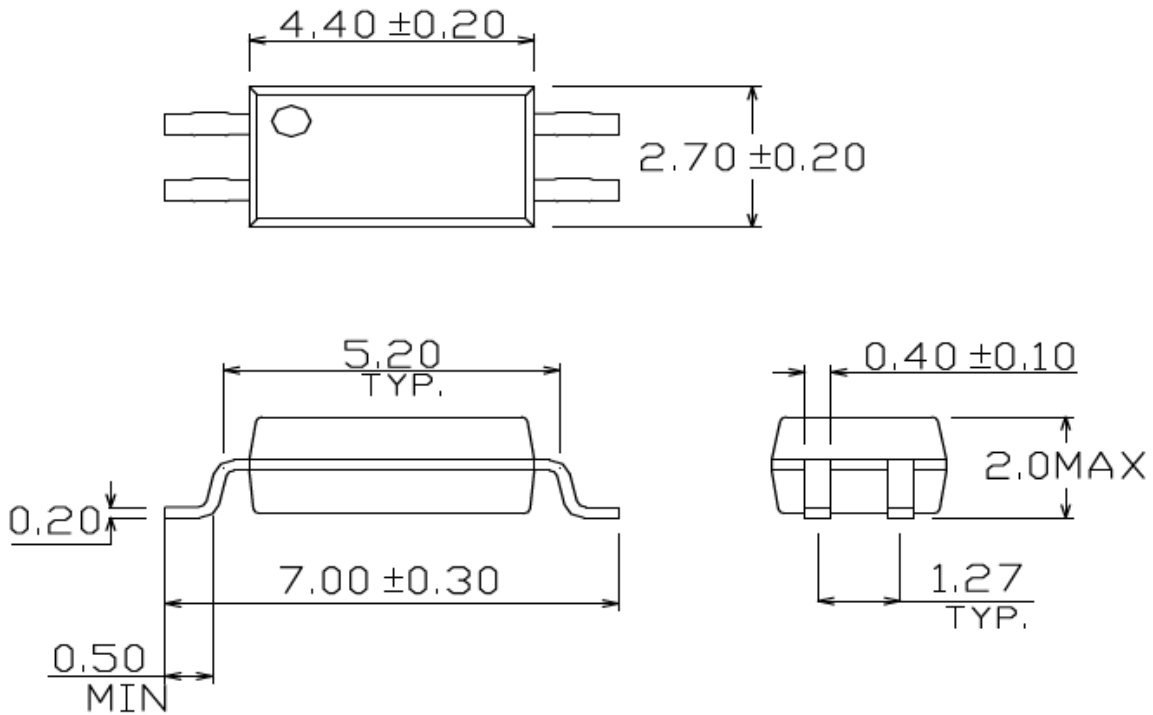

- 表面贴装引线框架及推荐焊盘布局 Recommended pad layout for surface mount leadform

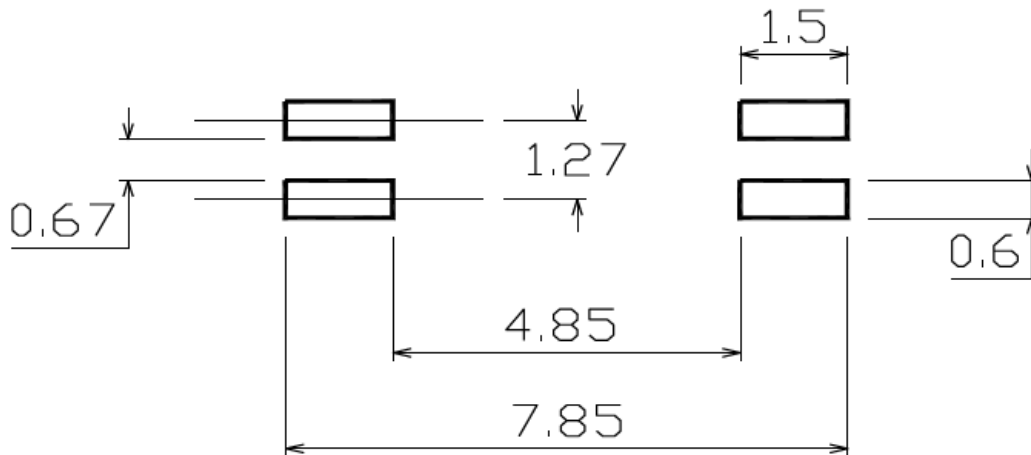

附注(Notes):

- 推荐焊盘尺寸仅供参考 Suggested pad dimension is just for reference only
- 请根据个人需要修改焊盘尺寸 Please modify the pad dimension based on individual need

## 11. 设备标记 Device marking

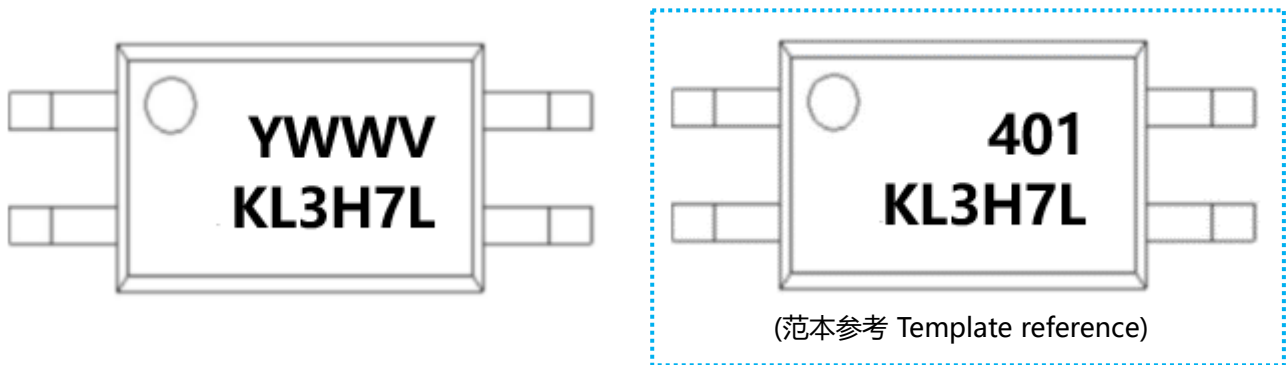

### 附注(Notes):

KL = 表示晶台光电有限公司 Denotes KingLight

3H7L = 表示材料部件号 Denotes Device Part Number

Y = 表示1位年份代码 Denotes 1 digit Year code

WW = 表示2位周别代码 Denotes 2 digit Week code

V = 表示VDE标识(客户指定镭射字符才加"V")  
VDE (Only add "V" to laser characters specified by the customer)

## 12. 料带和卷轴包装规格 Tape & Reel Packing Specifications

• 选择TA Option TA

• 选择TB Option TB

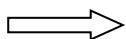
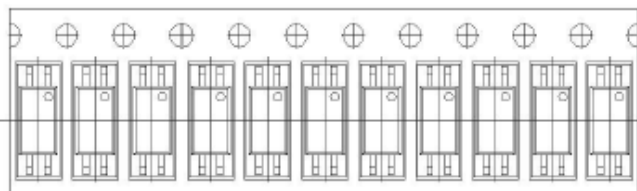

卷轴进给方向 Direction of feed from reel

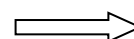

卷轴进给方向 Direction of feed from reel

### 料带尺寸 Material belt size

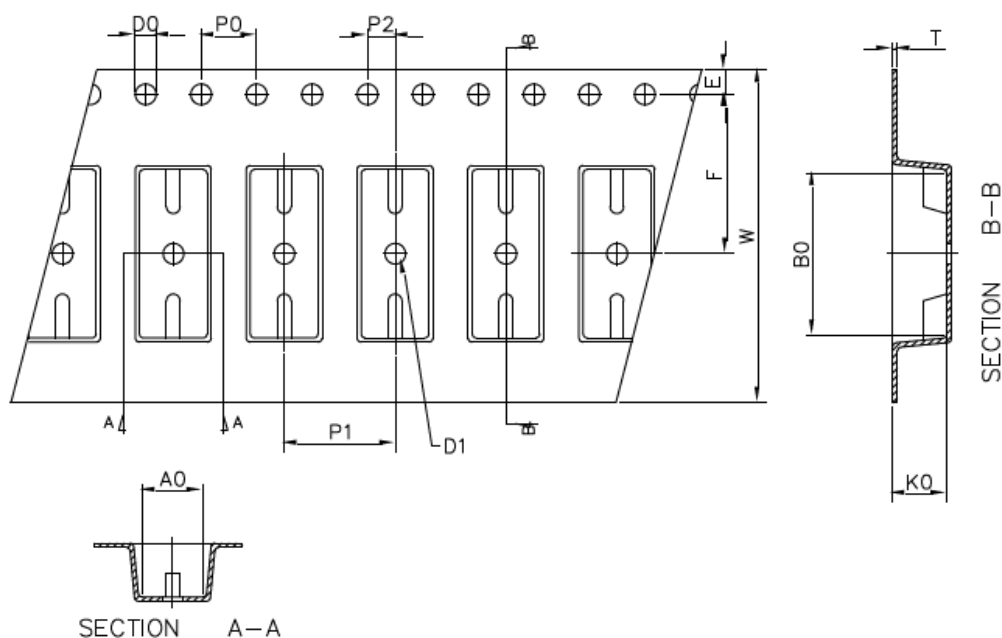

尺寸编号 Dimension No.	A0	B0	D0	D1	E	F
尺寸(mm) Dimension(mm)	3.0±0.10	7.45±0.1	1.5+0.10/-0	1.5±0.10	1.75±0.1	5.5±0.1
尺寸编号 Dimension No.	P0	P1	P2	t	W	K0
尺寸(mm) Dimension(mm)	4.0±0.15	8.0±0.1	2.0±0.10	0.3±0.05	12.1±0.2	2.45±0.1

### 13. 焊接温度曲线 Temperature Profile Of Soldering

#### • 回流焊温度曲线 Reflow soldering

建议在下面所示的温度和时间分布条件下, 进行一次回流焊作业, 不得超过三次

One time soldering reflow is recommended within the condition of temperature and time profile shown below. Do not solder more than three times.

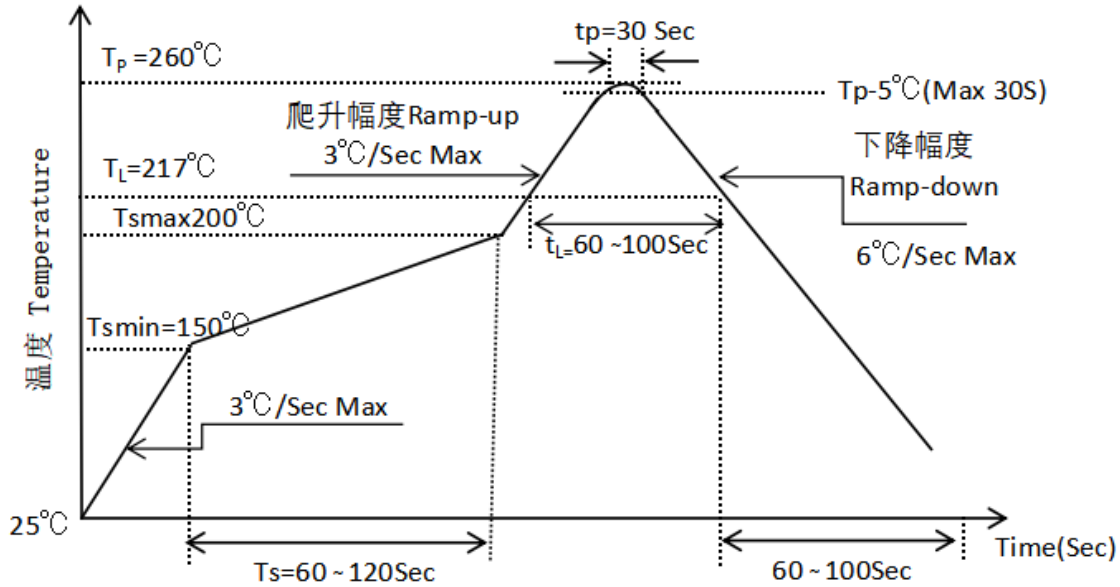

项目 Item	符号 Symbol	最小值 Min.	最大值 Max.	单位 Unit
预热温度 Preheat Temperature	$T_s$	150	200	$^{\circ}\text{C}$
预热时间 Preheat Time	$t_s$	60	120	s
升温速率 Ramp-Up Rate ( $T_L$ to $T_P$ )	-	-	3	$^{\circ}\text{C}/\text{s}$
液相线温度 Liquidus Temperature	$T_L$	217		$^{\circ}\text{C}$
高于液相线温度( $T_L$ )的时间 Time above Liquidus Temperature $T_L$	$t_L$	60	100	s
峰值温度 Peak Temperature	$T_P$	-	260	$^{\circ}\text{C}$
$T_c$ 在( $T_P-5$ )和 $T_P$ 之间的时间 Time During Which $T_c$ Is Between ( $T_P-5$ ) and $T_P$	$t_p$	-	30	s
降温速率 Ramp-down Rate( $T_P$ to $T_L$ )	-	-	6	$^{\circ}\text{C}/\text{s}$